

Eliminator HD302 Actuator
With Switch Tracks for Mounting Limit Switches
English Dimensions

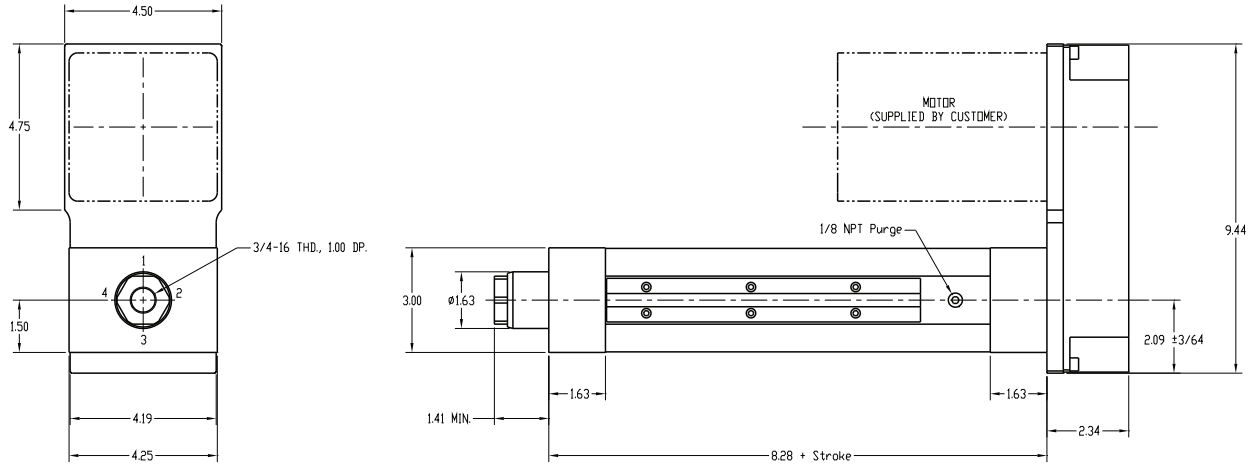

Motor Mount Configurations (choose one)

HD302 Parallel Offset Motor Configuration



HD302 Inline Motor Configuration

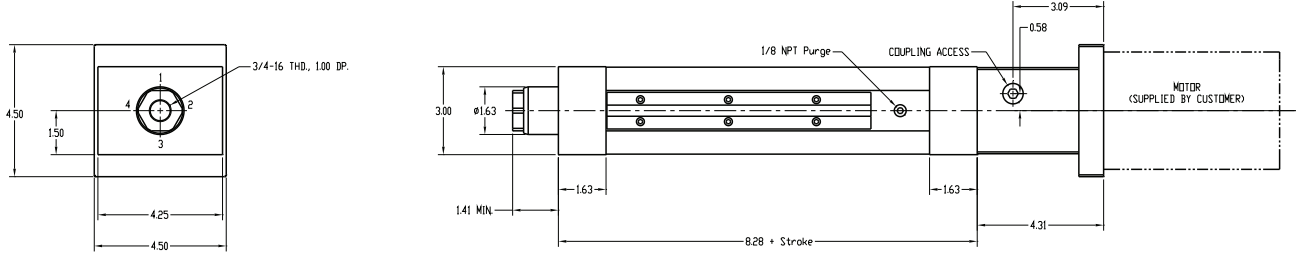

HD302 Rod End Conditions (choose one)

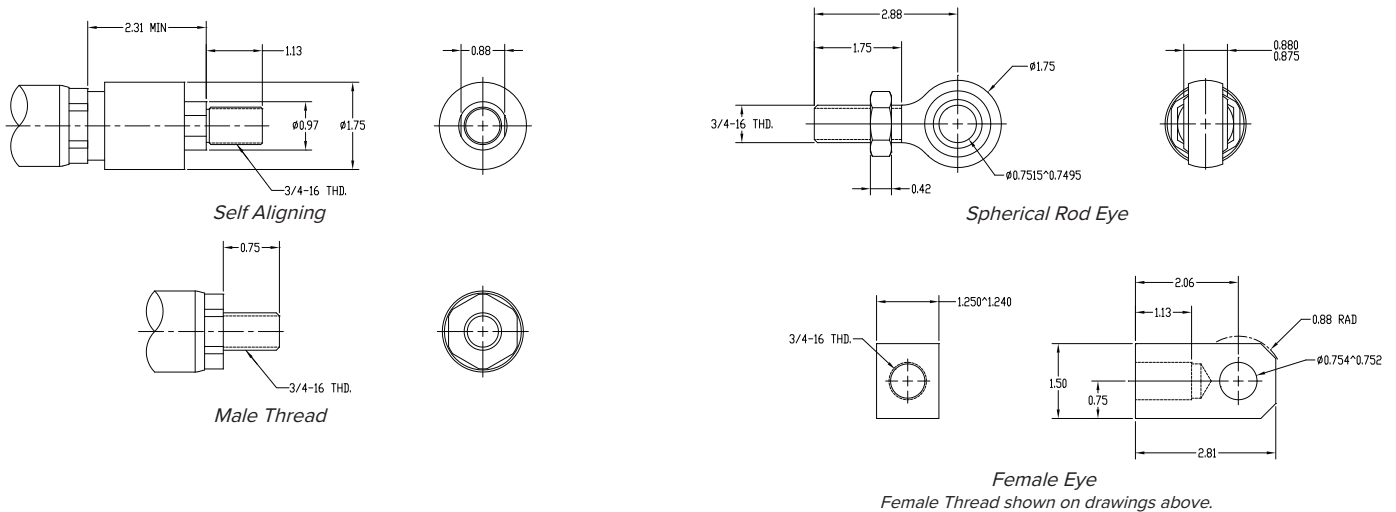

Eliminator HD302 Actuator
With Switch Tracks for Mounting Limit Switches
English Dimensions



HD302 Actuator Mount Configurations (*choose one*)

HD302 Bottom Mount Dimensions

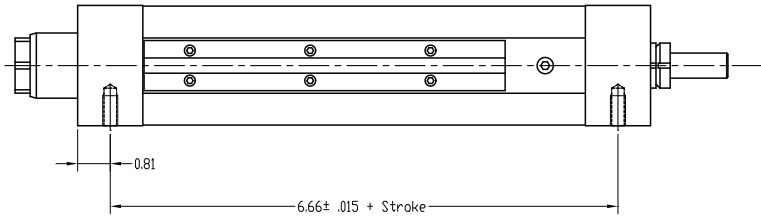
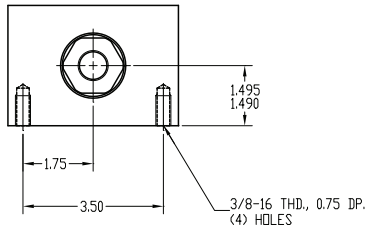

HD302 Front Flange Mount Dimensions

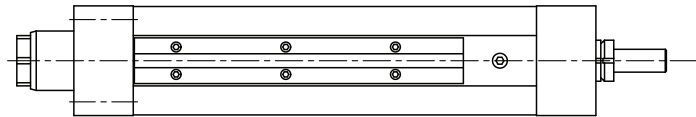
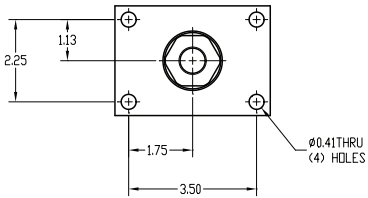

HD302 Foot Mount Dimensions

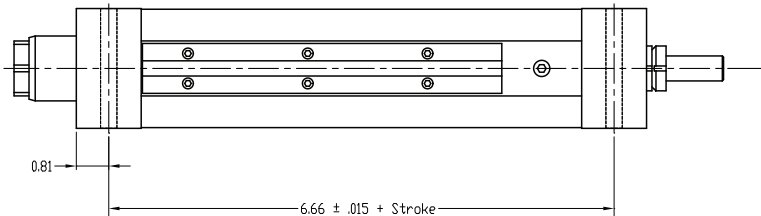
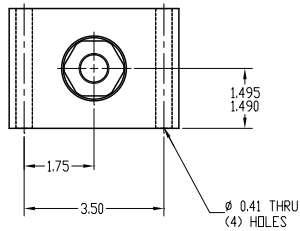

HD302 Trunnion Front Mount or Rear Mount Dimensions

