

Eliminator HD304 Actuator
Without Switch Tracks for Mounting Limit Switches
English Dimensions

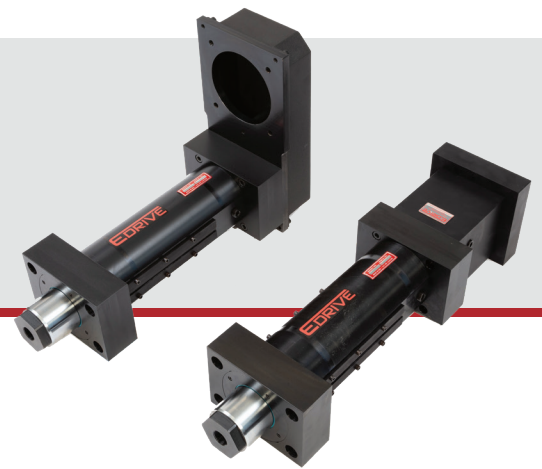

Motor Mount Configurations (choose one)

HD304 Parallel Offset Motor Configuration

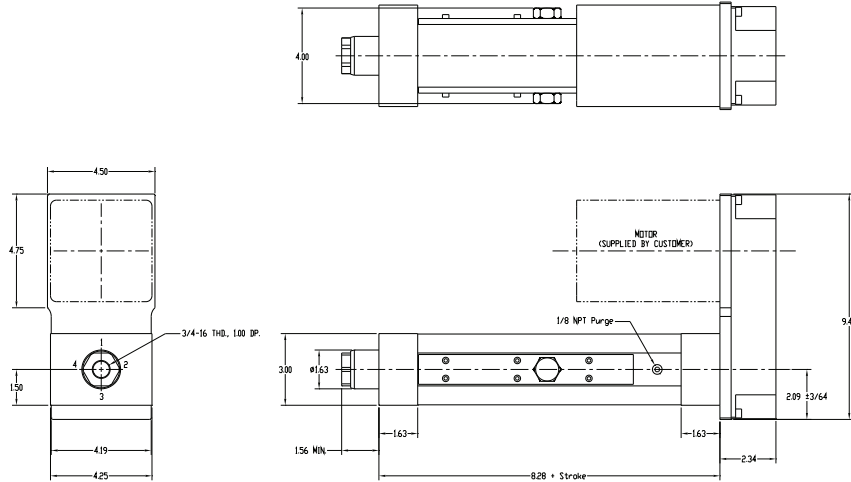

HD304 Inline Motor Configuration

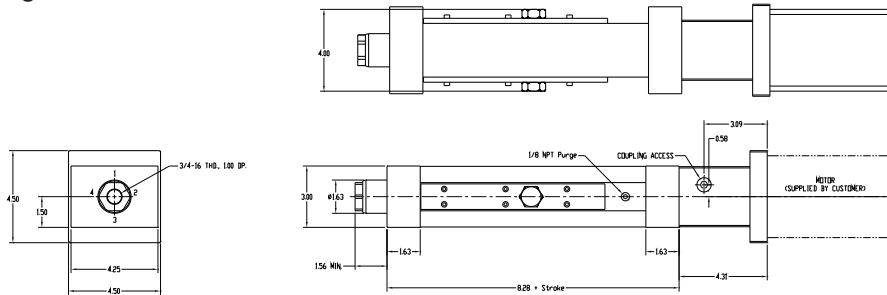

HD304 Rod End Conditions (choose one)

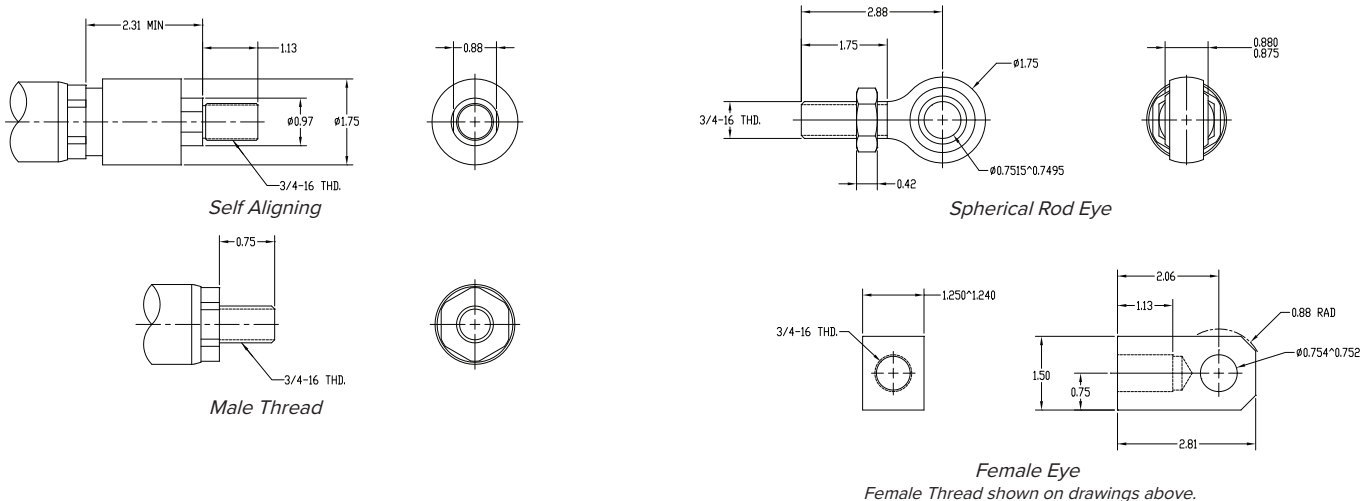

Eliminator HD304 Actuator
Without Switch Tracks for Mounting Limit Switches
English Dimensions



HD304 Actuator Mount Configurations (*choose one*)

HD304 Bottom Mount Dimensions

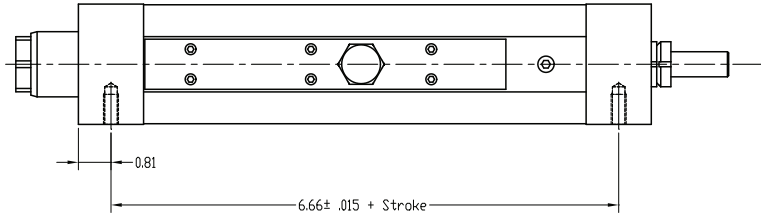
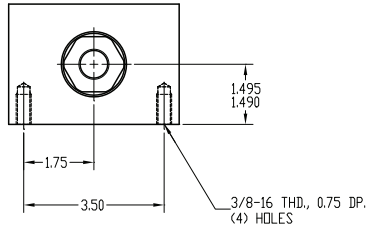

HD304 Front Flange Mount Dimensions

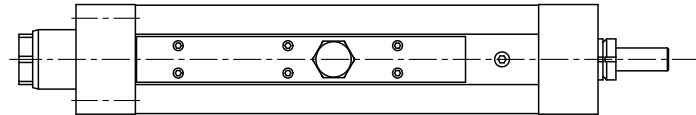
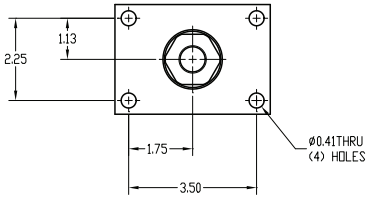

HD304 Foot Mount Dimensions

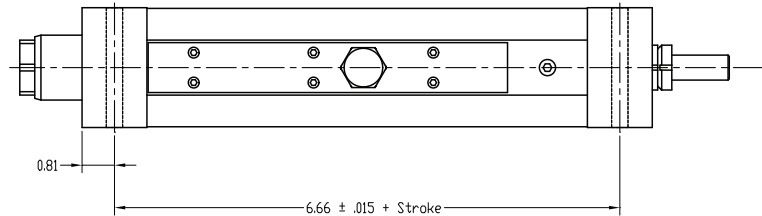
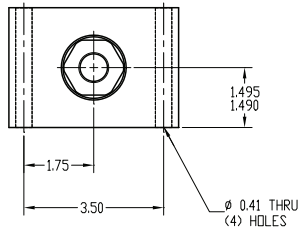

HD304 Trunnion Front Mount or Rear Mount Dimensions

