

Eliminator HD404 Actuator
With Switch Tracks for Mounting Limit Switches
Metric Dimensions

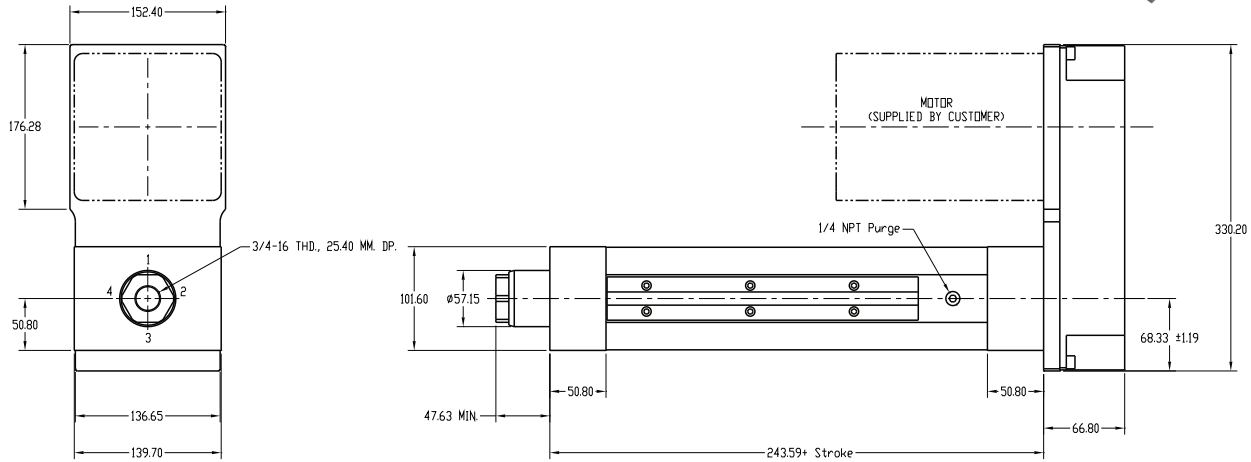

Motor Mount Configurations (choose one)

HD404 Parallel Offset Motor Configuration



HD404 Inline Motor Configuration

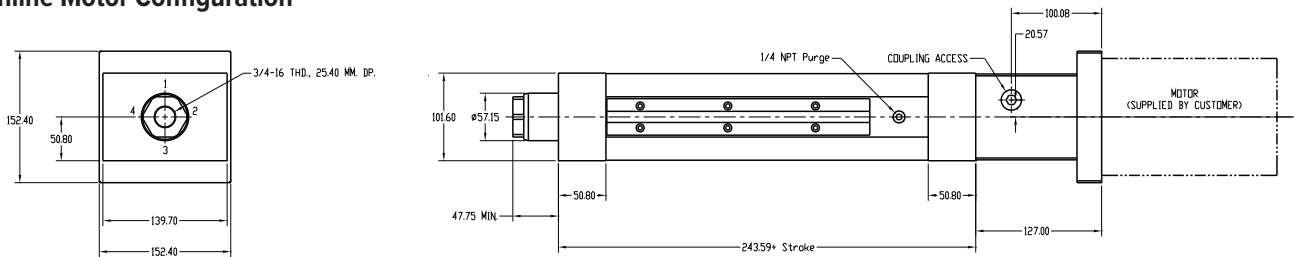

HD404 Rod End Conditions (choose one)

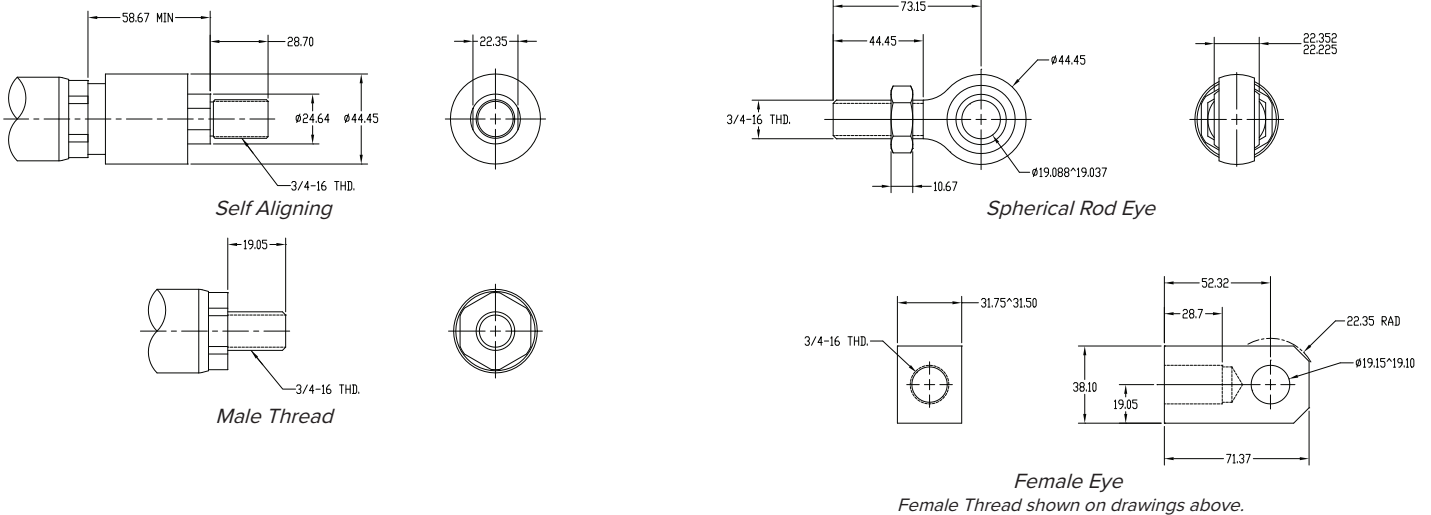

Eliminator HD404 Actuator
With Switch Tracks for Mounting Limit Switches
Metric Dimensions

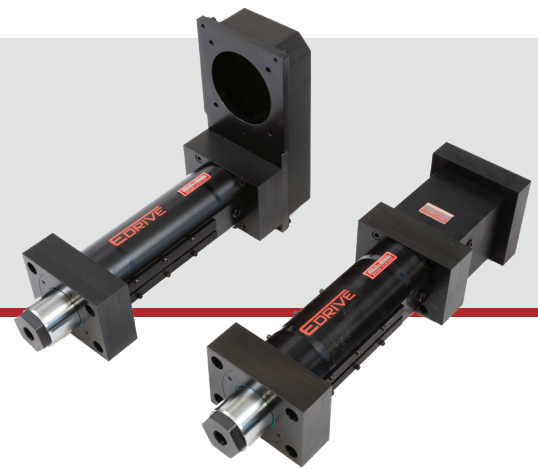

HD404 Actuator Mount Configurations (*choose one*)

HD404 Bottom Mount Dimensions

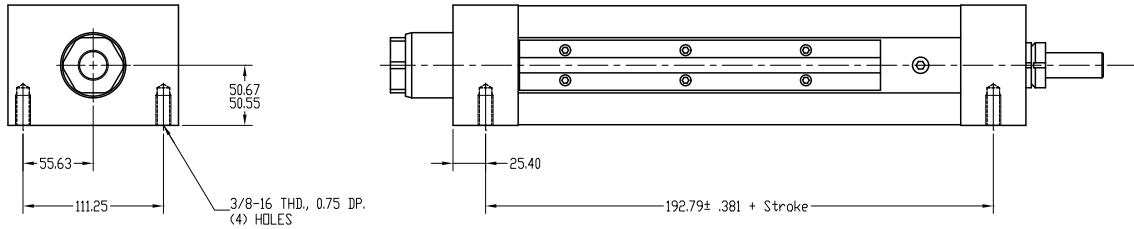

HD404 Front Flange Mount Dimensions

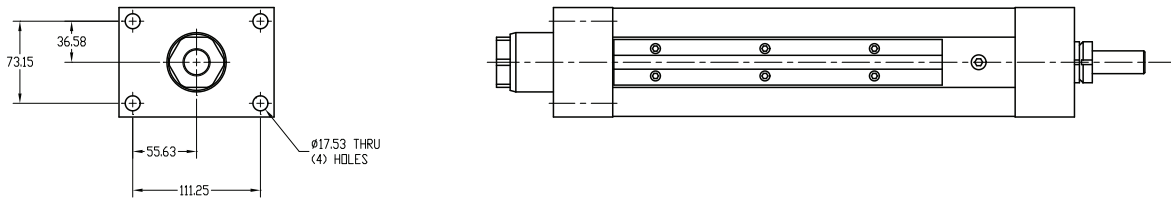

HD404 Foot Mount Dimensions

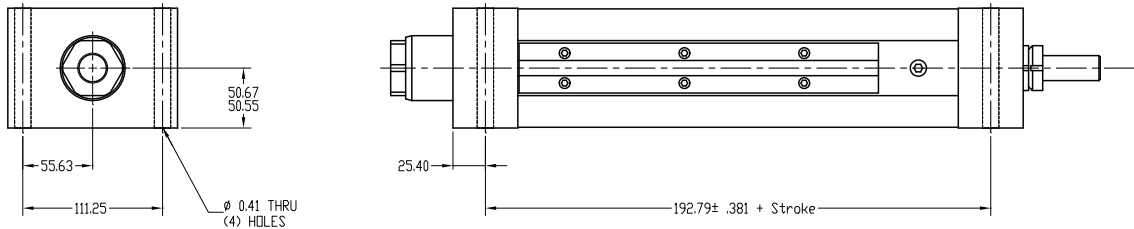

HD404 Trunnion Front Mount or Rear Mount Dimensions

