

**Eliminator HD516 Actuator**  
With Switch Tracks for Mounting Limit Switches  
Metric Dimensions

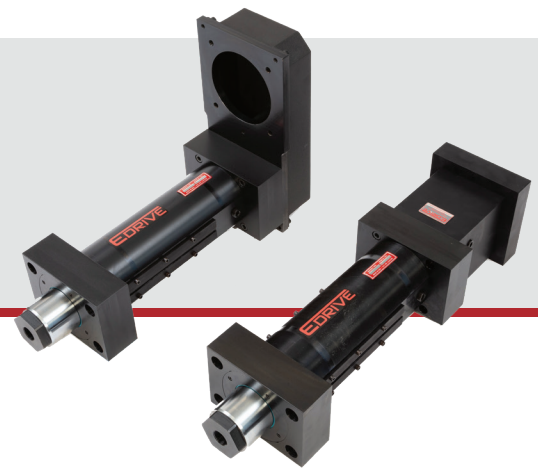

**Motor Mount Configurations** (choose one)

**HD516 Parallel Offset Motor Configuration**

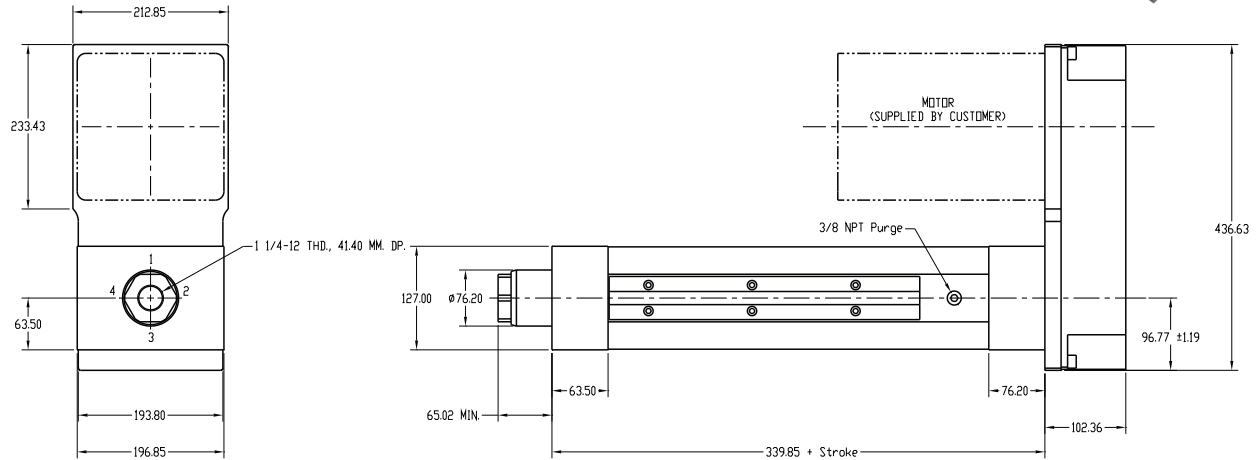

**HD516 Inline Motor Configuration**

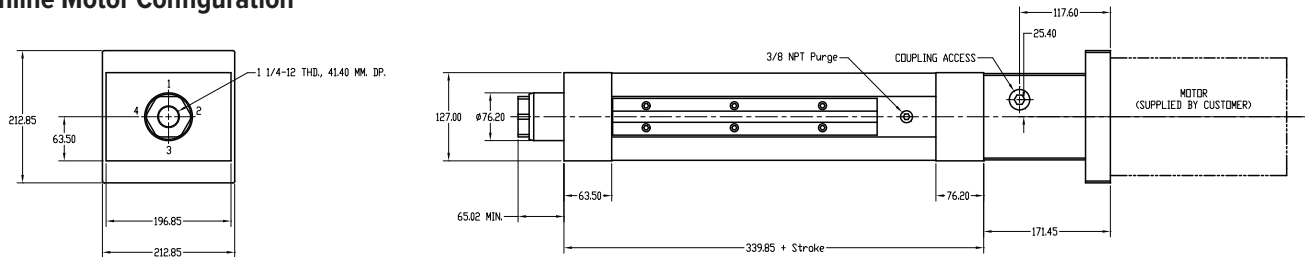

**HD516 Rod End Conditions** (choose one)

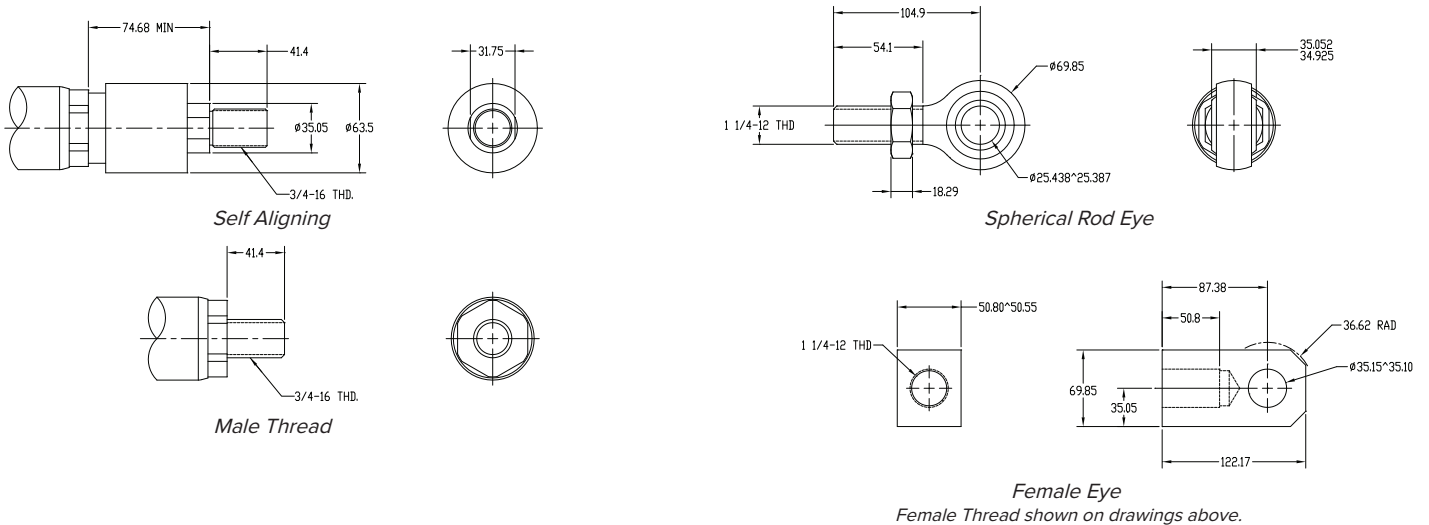

**Eliminator HD516 Actuator**  
With Switch Tracks for Mounting Limit Switches  
Metric Dimensions

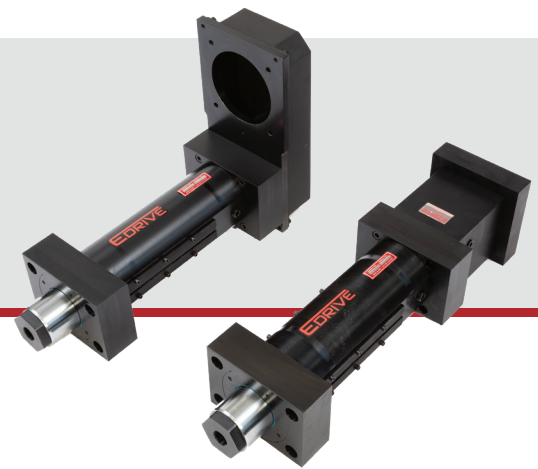

**HD516 Actuator Mount Configurations** (*choose one*)

**HD516 Bottom Mount Dimensions**

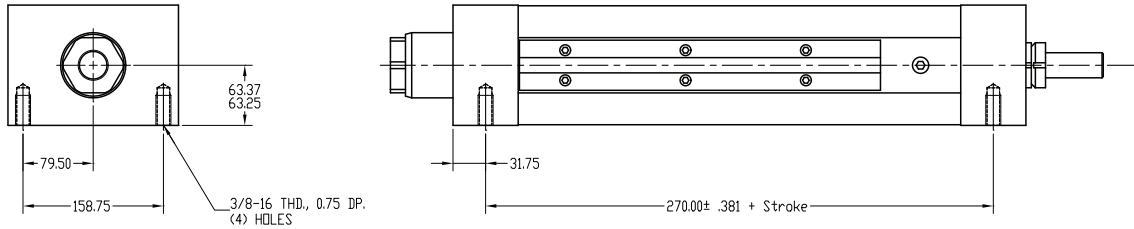

**HD516 Front Flange Mount Dimensions**

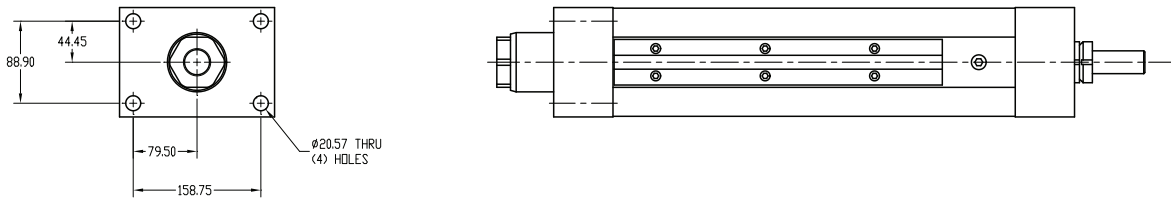

**HD516 Foot Mount Dimensions**

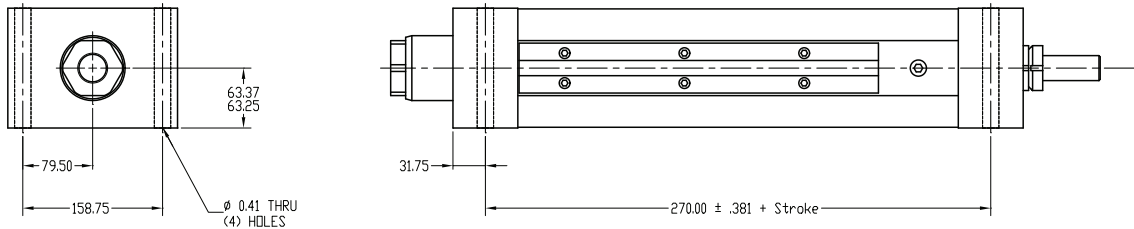

**HD516 Trunnion Front Mount or Rear Mount Dimensions**

